

HVM 063 Page 1/4

Elektrohydraulic Servovalves Typ HVM 063

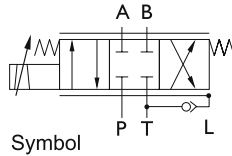
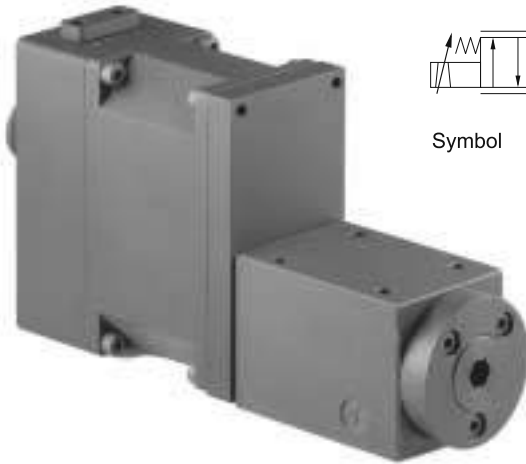

Special features:

- high reliability
- easy service
- robust construction
- high dynamic response
- relatively insensitive to contamination
- variable metering orifices only
- $Q_{max} = 20\text{l/min}$ at $\Delta p = 70\text{bar}$
- $p_{max} = 315\text{ bar}$

General description:

Type	:	electrical input stage, torque motor, sliding spool system
Pilot	:	none
main spool	:	directly controlled 4-way sliding spool
Style of mounting	:	subplate / Cetop 03
Mounting position	:	unrestricted
Weight	:	1,5kg

Technical Data

1. Hydraulic Data (definition according to DIN 24311)

.1	rated pressure	p_N	=	210 120	[bar] (HVM 063-010) [bar] (HVM 063-020)
.2	operating pressure	$p_{b\ min}$ $p_{b\ max}$	=	10	[bar]
.2.1	return line pressure	$p_{r\ max}$	=	10	315 [bar] static
.2.2	no separate leakage line necessary				
.3	max. pressure (static test pressure)	p_{max}	=	450	[bar]
.4	rated flow at $\Delta p = 70\text{ bar}$	Q_N	=	10/20	[l/min]
.5	quiescent flow, max. at p_N	Q_0	<	5% Q_N	
.6	hysteresis	H	<	5% i_N 3% i_N	(without Dither) (with Dither)
.7	threshold sensitivity	E	<	0,4% i_N 0,1% i_N	(without Dither) (with Dither)
.8	threshold span	S	<	2% i_N 1% i_N	(without Dither) (with Dither)
.9	linearity deviation		<	10% i_N	
.10	flow symmetry $-Q_N$ zu $+Q_N$		<	10% i_N	
.11	pressure gain (see diagram)	V_N	>	0,4 $P_b / 1\% i_N$	
.12	overlap, standard	h	=	-1...+3% i_N	
.13	operating temperature range	δ_M	=	253...353	[K]
.13.1	temperature drift		≤	2% $i_N / 50K$	
.14	viscosity range of fluid	γ_{min}	=	10...1000 mm^2/s approximate value normal: ISO VG 10...ISO VG 46	
.15	filtration of fluid		<	class 4-5 to NAS 1638 or class 15/14/11 to ISO 4406	
.16	fluid standard		=	HLP-hydraulic oils as per DIN 51524 Teil 2 (Special equipments possible)	

HVM 063 Page 2/4

2. Diagrams HVM 063

Flow rate-signal function

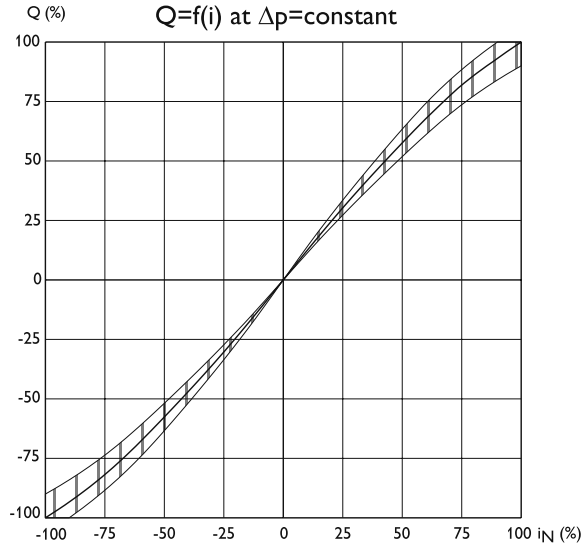

Pressure gain

$$V_p = \tan \alpha = \frac{\Delta p}{\Delta I}$$

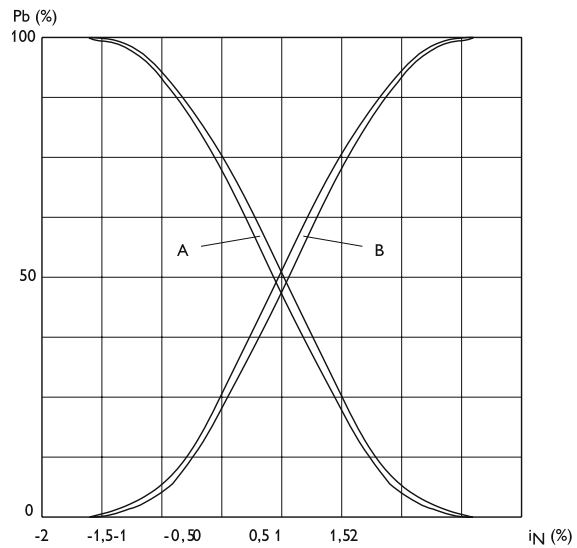

Frequency Response

Coils: $1 \times 12 \Omega$
 Power Supply: $\pm 32V$
 P_V : 210bar

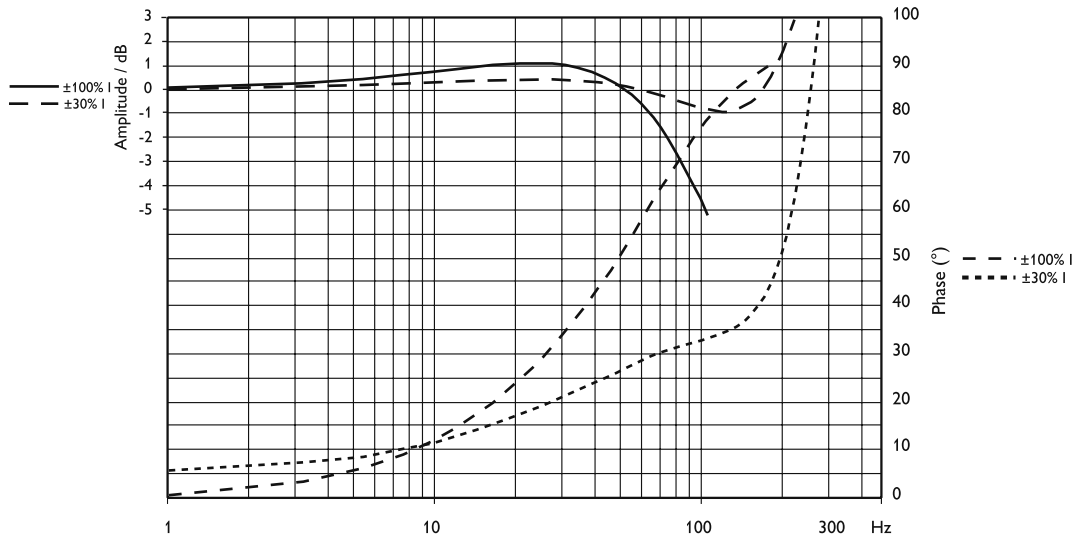

HVM 063 Page 3/4

3. Electrical Data

3.1 Electrical Data without Electronic

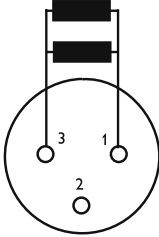
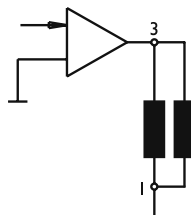
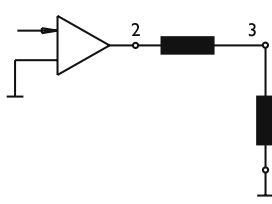
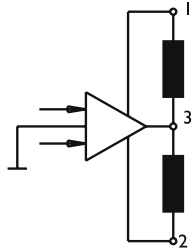
																
connector (M8x1) Standard-coils parallel at 1 and 3; 2 NC					technical Data per coil, 2 coils operated			Standard version coils parallel 3 +V, 1 0V flow from P to B			Special equipment Coils serially 2+V, 1 -V flow from P to B			Special equipment Coils 3 to 1 > 3 to 2 flow from P to A		
coil type	inductance / coil	rated current	resistance	power	rated current	resistance	power	rated current	resistance	power	rated current	resistance	power			
1	22 mH	± 150 mA	55Ω	1,25 W	± 300 mA	27,5 Ω	2,5 W	± 150 mA	110 Ω	2,5 W	360 mA	60Ω	5 W			
2	5 mH	± 325 mA	12Ω	1,25 W	± 650 mA	6 Ω	2,5 W	± 325 mA	24 Ω	2,5 W	650 mA	11Ω	4 W			

.2.1 Electrical Data with Electronic

Power supply: 24V DC (18V ... 28V)
 Current: 350mA max.
 Input signal: -10V ... 0,0 ... +10V
 Input resistance: 100 kohm
 Signal direction: from Pin D to Pin E
 Internal coil current: 300mA ... 0mA ... -300mA
 Test signal output: 3Volt ... 0V ... -3 Volt
 Valve oil flow: 100% ... 0% ... -100%
 Flow direction: +10V = P > A - B > T
 0,0V = Valve closed
 -10V = P > B - A > T

Reminds:

To avoid potential drifting problems, connect Pin E with low resistance (< 10 ohm) to Pin B.

The electrical-hydraulic working direction can be changed to reversed connection on Pin D and Pin E

Cable recommendation:

twisted pair cable up to cable length 25 mtr.:
 Type LiYCY 3x2x0,5 mm² or LiYCY4x2X0,5mm², if you will use the test signal out.
 up to cable length 200 mtr.:
 Type LiYCY 3x2x0,75 mm² or LiYCY 4x2x 0,75 mm², if you will use the test signal out.

.2.2 Bloc diagram

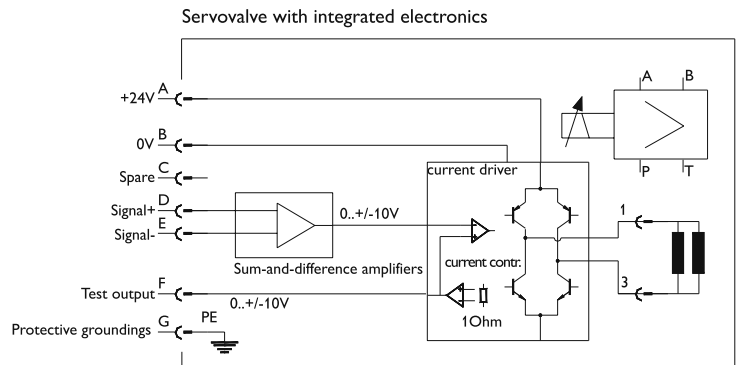

connector 7 pol.
DIN 43563

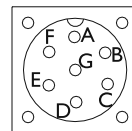

View on the valve
Pins visible

HVM 063 Page 4/4

Order Information

HVM 063 - 020 - 1200 - XX - E1

Model

063

Rated flow

QN at $\Delta p = 70$ bar
 010 l/min
 020 l/min

Seal material

- 1 Perbunan
- 2 Viton
- 3 Butyl
- 4 Vulkollan
- 5 Ethylen-Propylen

Resistance / coil [R20]

- 1 6 Ω (2x12 Ω parallel)
- 2 30 Ω (2x60 Ω parallel)
- 4 12 Ω (1coil)

Overlap

- 0 Zero overlap
- 1 Positiv overlap
- 2 Negativ overlap

Amount of overlap

positiv or negative
 1..9

Design letter

assigned by manufacturer

Elektronic

- E1 Voltage input $\pm 10V$
- E2 Current input 4...20mA P > A
- E3 Current input 4...20mA P > B

5. Accessories:

Description			Order No.
Connector	3pol.	KE 79-3406-52-03	10249
Connector 90°	3pol.	KE 79-3408-52-03	10250
Connector	7pol.	KE CA 06 COM 14S 7S	21855
Sub plate	NG 6	HZ 050	39276
scavenger plate	NG 6	HZ 062	39686
Box-Amplifier		BOE XXX-025-0-5-0A	46965

Important remarks:

Valve mounting surface must be flat within 0,02mm and smoothness not to exceed 6 μ m. Easy hydraulic Zero adjustment by means of Allen key S8 DIN 911. Max. permissible drain line pressure 10 bar. Valves with modified characteristics available. Modifications, which serve technical progress, remain reserving.

Für diese Vorlage bzw. Vorschrift techn. Art behalten wir uns alle Rechte vor. All rights reserved for this document (vgl. DIN 34)

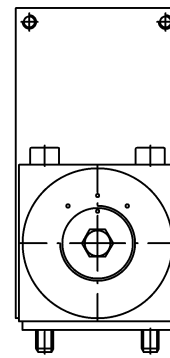
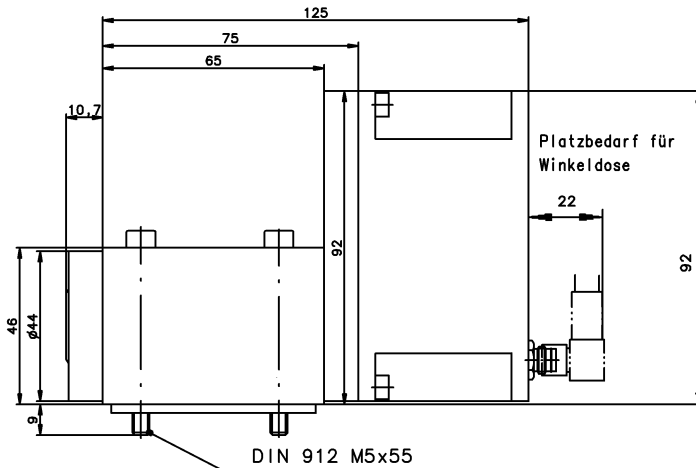
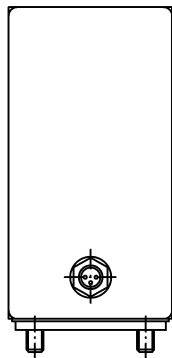
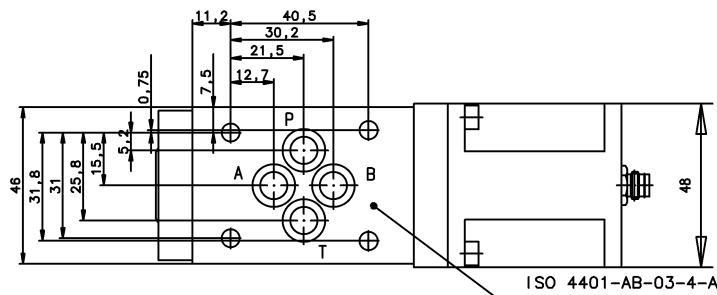

Lecköl mit Tank im Ventil über Rückschlagventil verbunden.
Aus diesem Grund darf der Tankdruck 10 bar statisch nicht überschreiten!

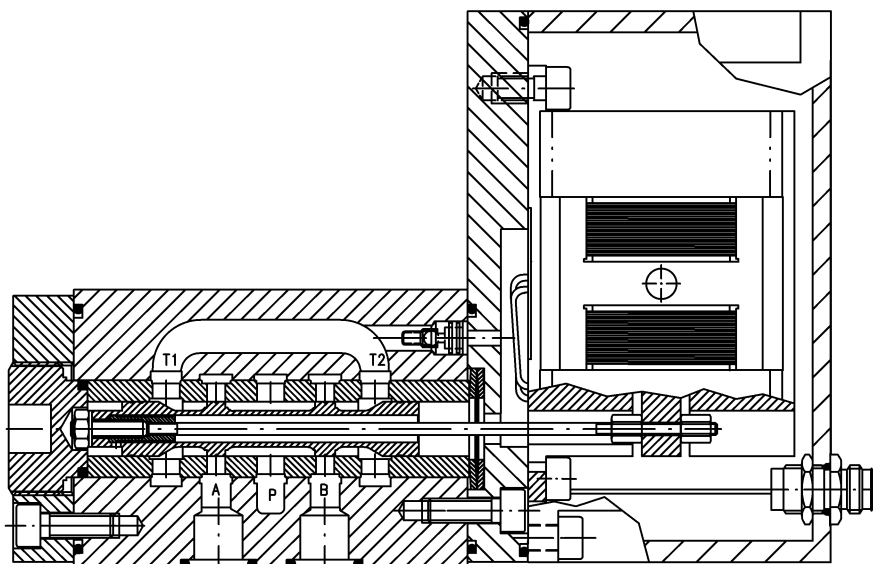
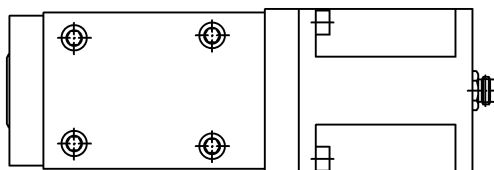

Angaben ohne Einheiten in mm
All dimensions without unit in mm

Nur zur Information / Only for information

Änderungsindex / Amendment index		Ventil Valve	HVM 063-0XX-1XXX-XA	Id.- Nr.
-				-
Datum Date	Name Name	Jos. Schneider Optische Werke GmbH Ringstr. 132 55543 Bad Kreuznach Germany		
dwg.	10.10.02 Dindorf			

Für diese Vorlage bzw. Vorschrift techn. Art behalten wir uns alle Rechte vor. All rights reserved for this document (vgl. DIN 34)

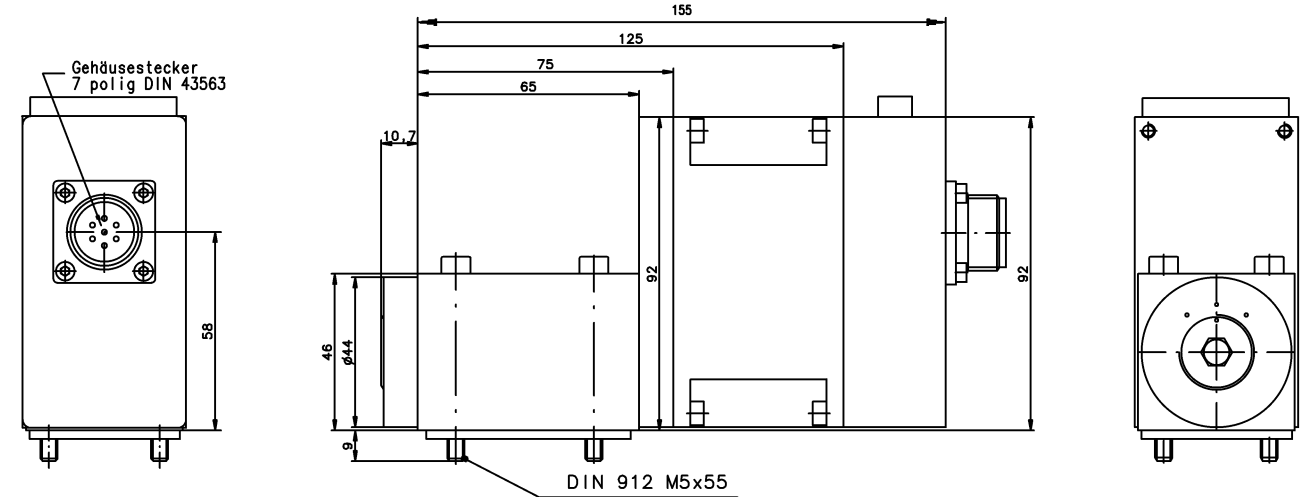
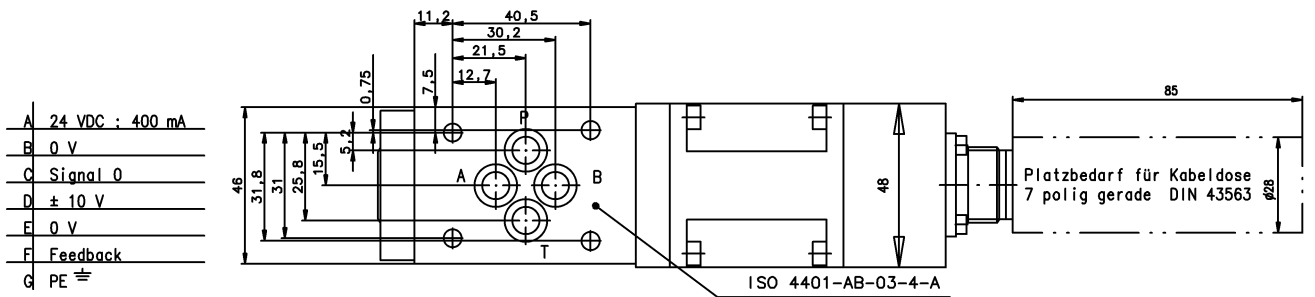

Lecköl mit Tank im Ventil über Rückschlagventil verbunden. Aus diesem Grund darf der Tankdruck 10 bar statisch nicht überschreiten!

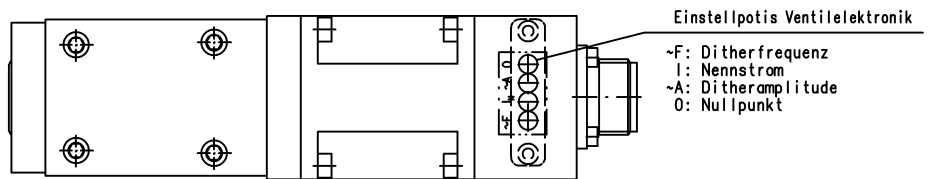

- F: Ditherfrequenz
- I: Nennstrom
- A: Ditheramplitude
- 0: Nullpunkt

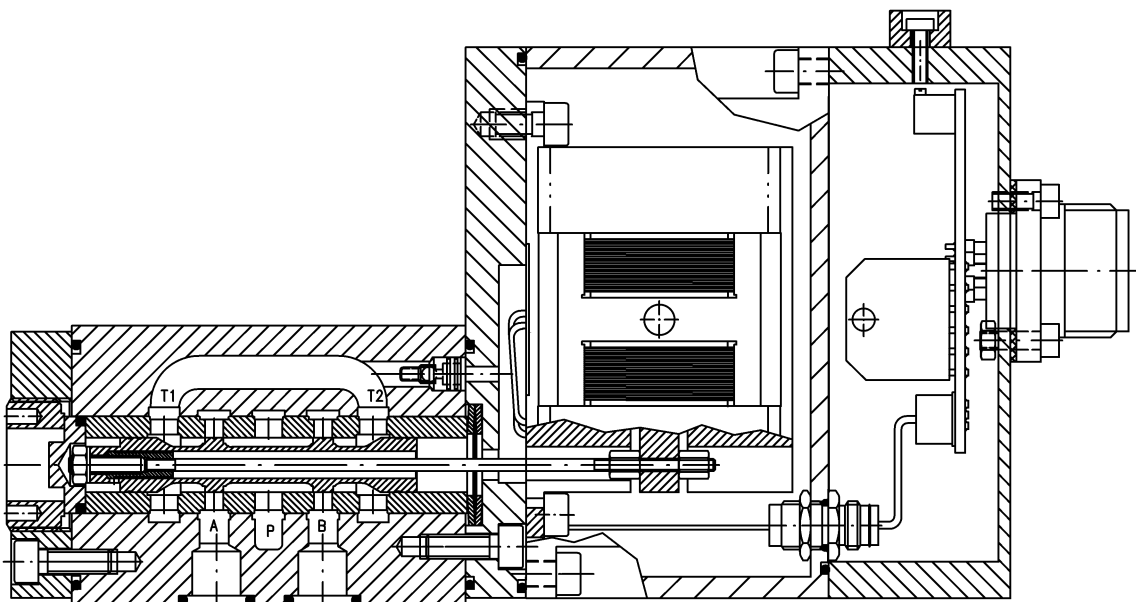

Angaben ohne Einheiten in mm
All dimensions without unit in mm

Nur zur Information / Only for information

Änderungsindex / Amendment index		Ventil Valve	HVM 063-XXX-XXXX-XX-EX	Id.- Nr. -
Datum Date	Name Name			
dwg.	10.10.02	Dindorf	Jos. Schneider Optische Werke GmbH Ringstr. 132 55543 Bad Kreuznach Germany	